

ACME-SHOREY

PRECAST CONCRETE PRODUCTS

WWW.ACMESHOREY.COM

PHONE (508) 548-9607

FAX (508) 548-1664

CARVER, MA
334 TREMONT STREET

HARWICH, MA
36 GREAT WESTERN ROAD

NOTES:
1.) DRAINAGE PRODUCT.

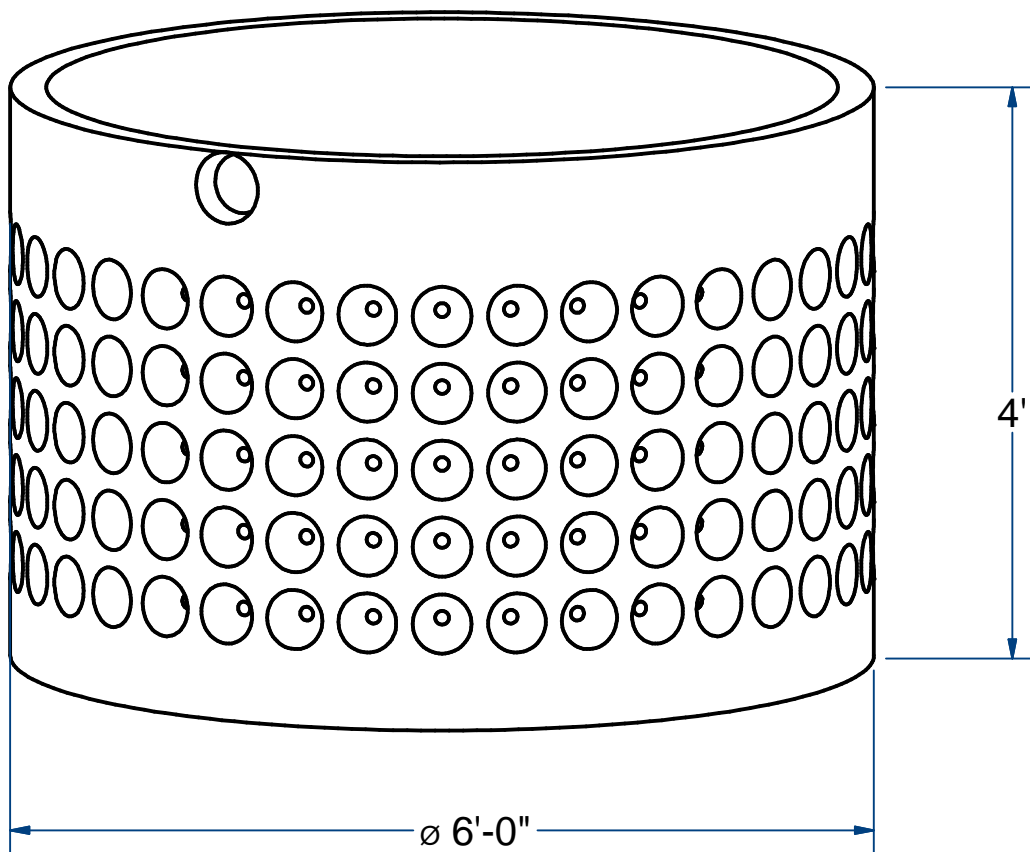

LEACHING SLEEVE

6' O.D. X 4' Ht.

600 Gallon

ITEM# LS4

Wt. 2,400 Lbs

12-5.1

Sht 1 of 2

ACME-SHOREY

PRECAST CONCRETE PRODUCTS

NOTES:
1.) DRAINAGE PRODUCT.

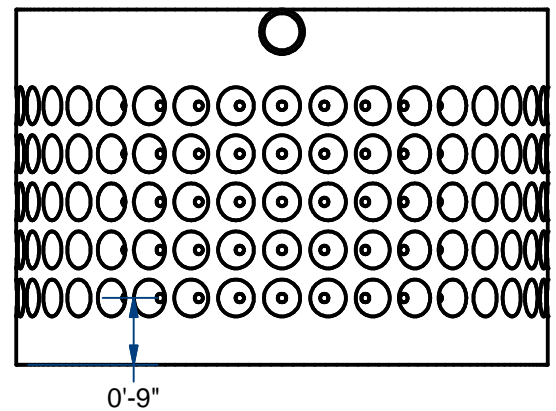
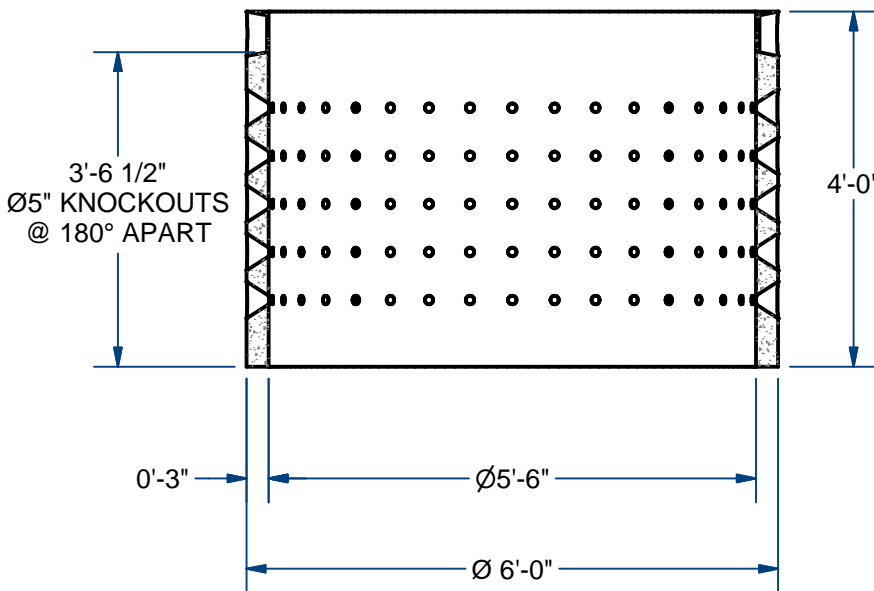
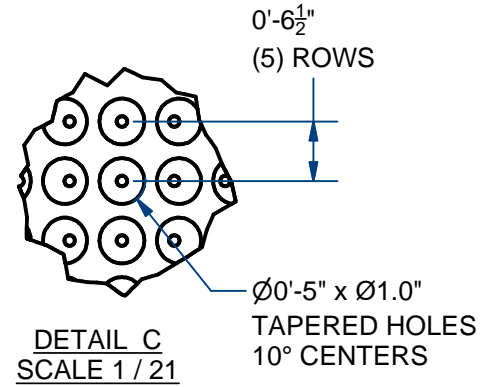
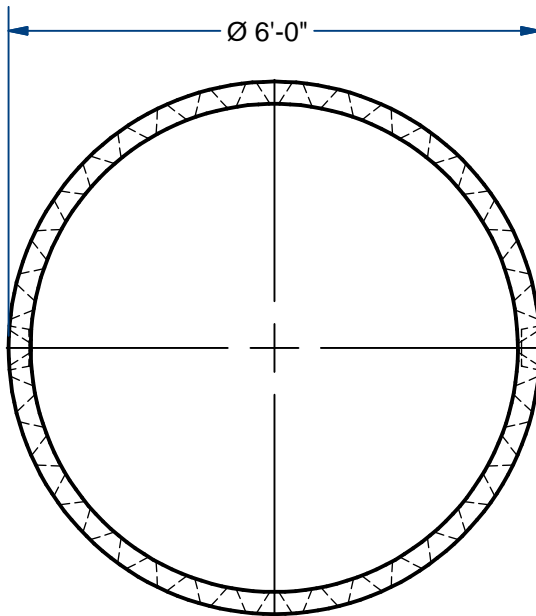

NAME: LEACHING SLEEVE, 600 Gallon

ITEM# LS4

Concrete Minimum Strength: 5,000 p.s.i. at 28 days
Steel Reinforcement: ASTM A615, Grade 60
Design Loading: standard units - AASHTO

WEIGHT 2,400 Lbs

A

DATE: 7-4-2018

Ch 12 Pg 5.1

Sht 2 of 2