

ACME-SHOREY

PRECAST CONCRETE PRODUCTS

WWW.ACME-SHOREY.COM

PHONE (508) 548-9607

FAX (508) 548-1664

CARVER, MA

334 TREMONT STREET

HARWICH, MA

36 GREAT WESTERN ROAD

NOTES:

- 1.) SEAM SEALED WITH FLEXIBLE BUTYL RUBBER SEALANT.

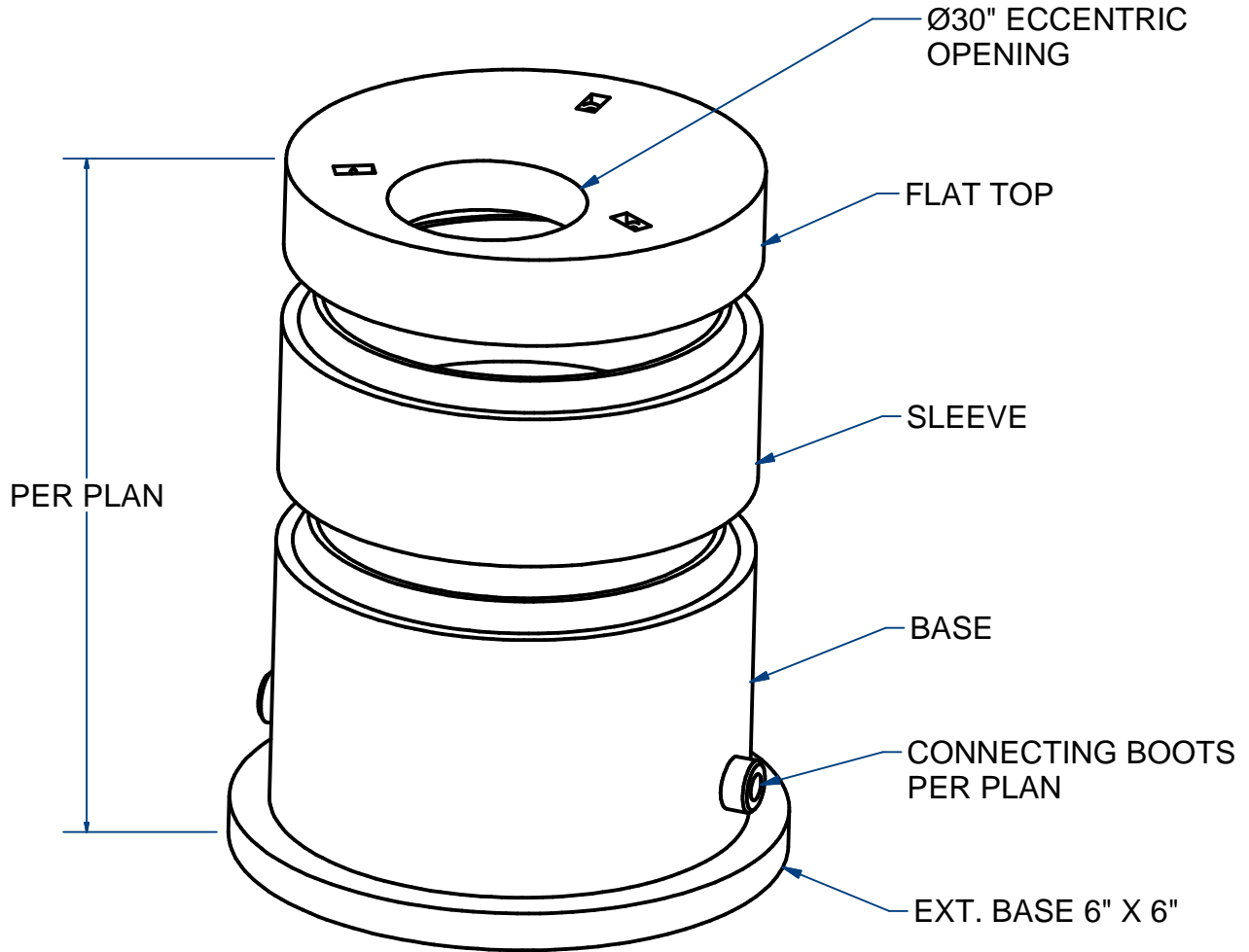

SEWER MANHOLE , 5'ID ECCENTRIC FLAT TOP EXTENDED BASE H20

ITEM# SMH5EFT30EB

Wt. TBD Lbs

18-2.33

Sht 1 of 2

ACME-SHOREY

PRECAST CONCRETE PRODUCTS

NOTES:

- 1.) SEAM SEALED WITH FLEXIBLE BUTYL RUBBER SEALANT.
- 2.) TAR COATING CONSEAL CS-55
- 3.) CONNECTING BOOTS
- 4.) STEPS PER ASTM C-478

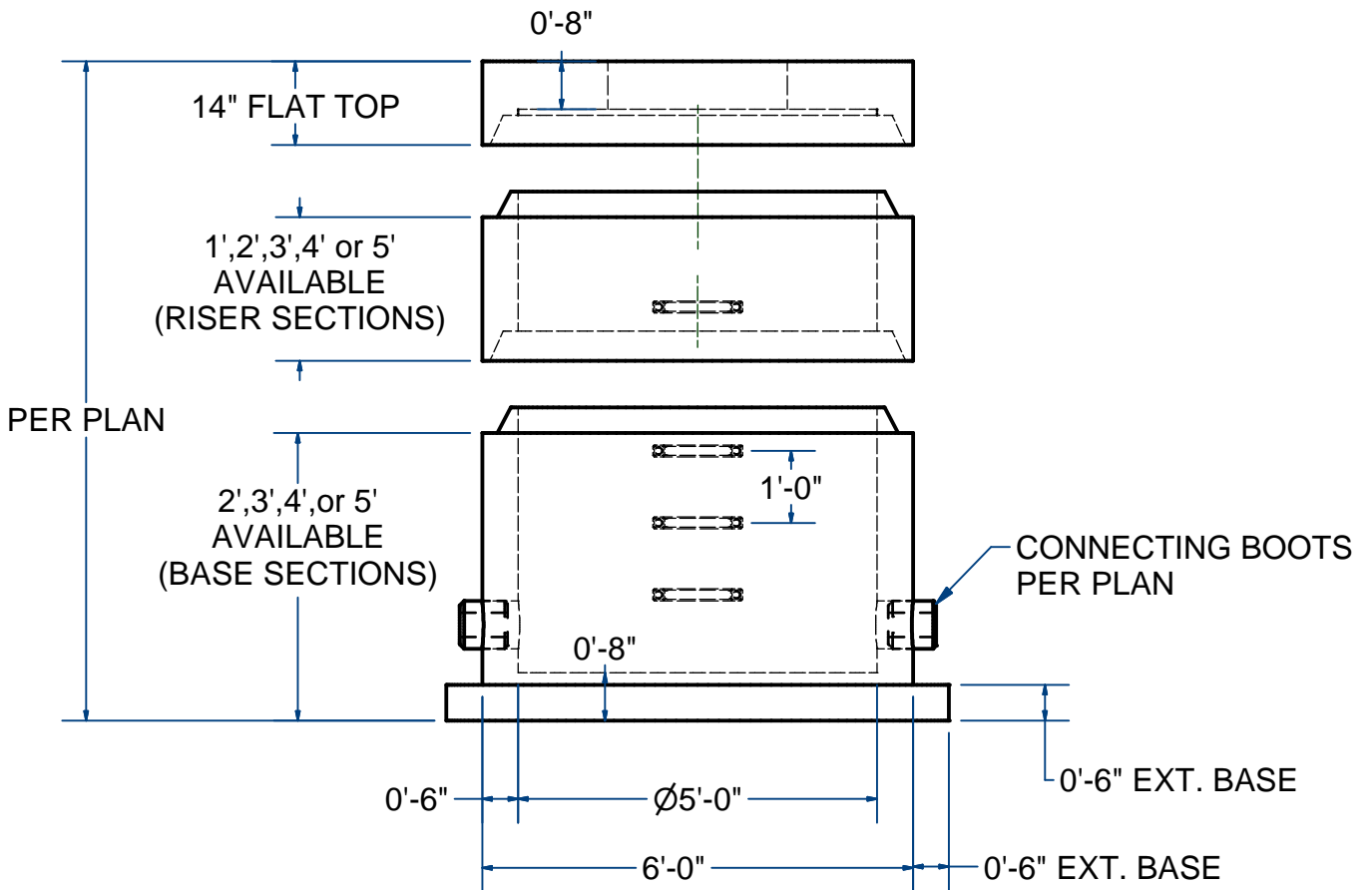
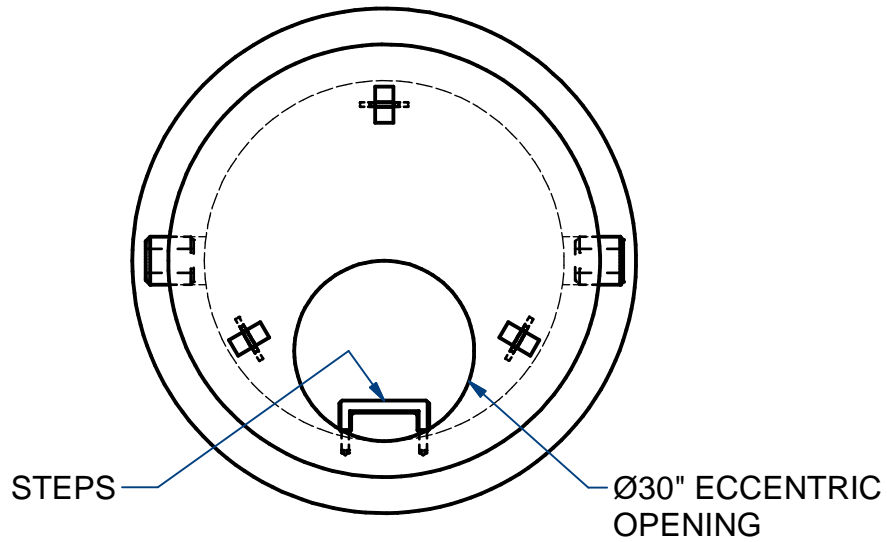

NAME: SEWER MANHOLE 5' ID, FLAT TOP
(Ø30" ECCENTRIC OPENING)

H-20

ITEM# SMH5EFT30EB

CONCRETE MIN. STRENGTH: 5,000 PSI @ 28 DAYS
STEEL REINFORCEMENT: ASTM A615, GRADE 60
DESIGN LOADING: STANDARD UNITS-AASHTO-H20

MANHOLES DESIGNED & FABRICATED
IN ACCORDANCE WITH AND CONFORMING
TO ASTM C478 PRECAST CONCRETE
MANHOLE SECTIONS.

C

DATE: 10-17-20