

NOTES:

- 1.) SEAM SEALED WITH FLEXIBLE BUTYL RUBBER SEALANT.

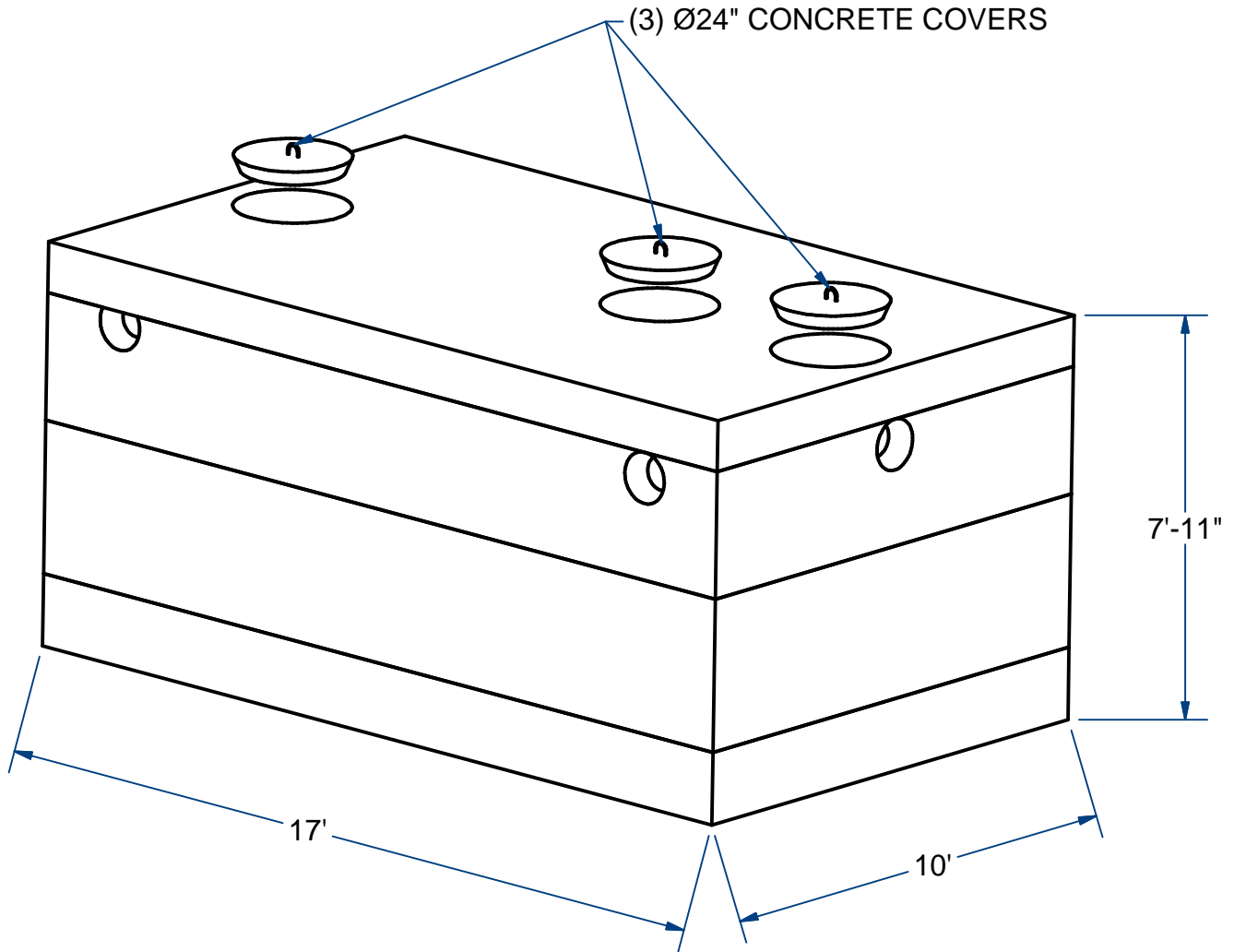

LOW PROFILE SEPTIC TANK 10'X17'

H20

6000 Gallon

ACME-SHOREY

PRECAST CONCRETE PRODUCTS

NOTES:

- 1.) SEAM SEALED WITH FLEXIBLE BUTYL RUBBER SEALANT.

Each Section	Wt ea. (Lbs)
Base 17"	21,500
Sleeve#1- 36"	13,500
K.O. Sleeve#2- 30"	11,250
Top 10"	21,250
	67,500

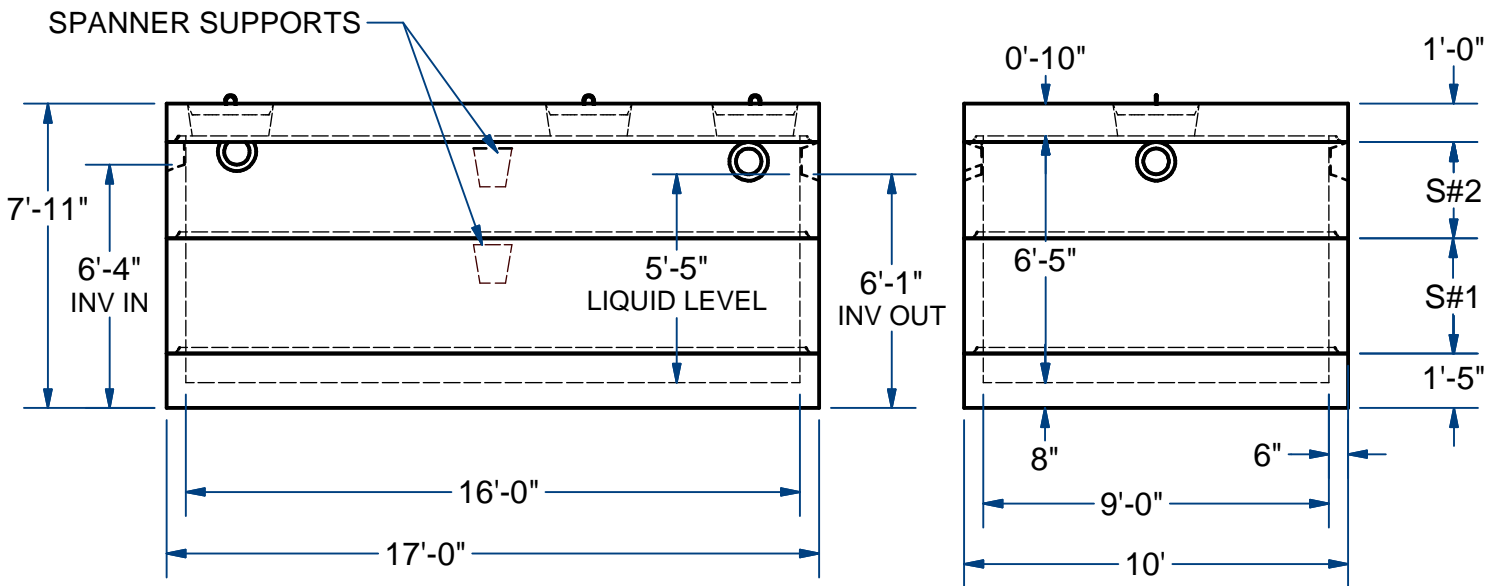
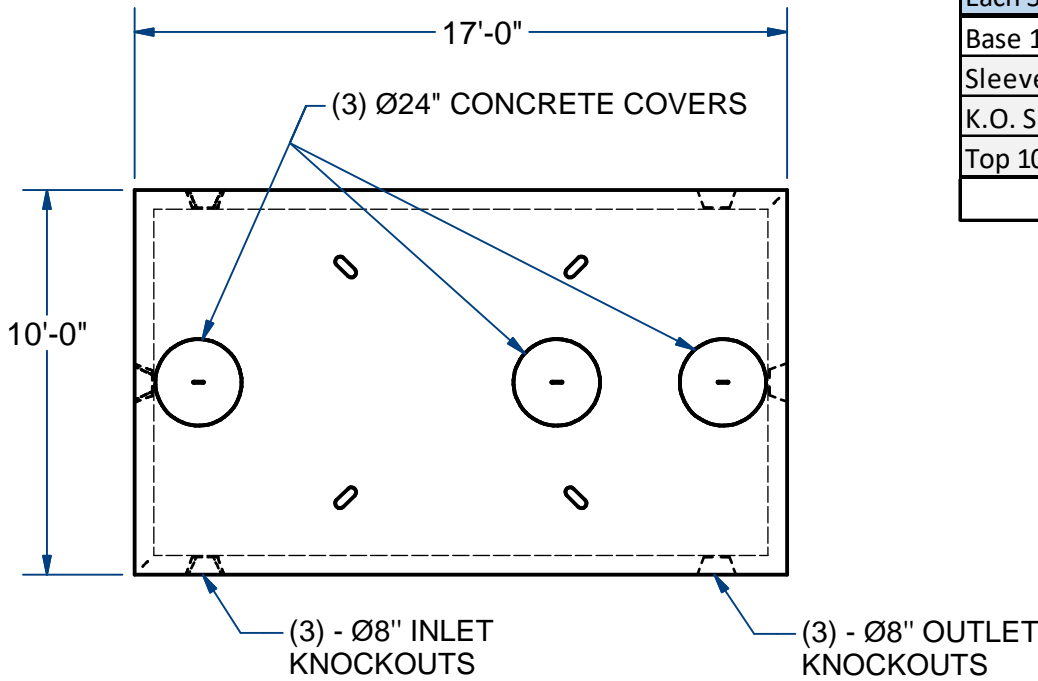

NAME: SEPTIC TANK 10' X 17', 6000 Gallon
(LOW PROFILE)

H-20

ITEM# ST1006

Concrete Minimum Strength: 5,000 p.s.i. at 28 days
Steel Reinforcement: ASTM A615, Grade 60
Design Loading: standard units - AASHTO - H20

WEIGHT 67,500 Lbs

H

DATE: 11-2-2019

Ch 8 Pg 16.2 Sht 2 of 2